

INSTRUCTIONS

MODBUS TCP CARD

RIGHT FROM
THE START

AuCom
MOTOR CONTROL SPECIALISTS

Contents

1. Introduction	3
2. Installation.....	4
3. Device configuration.....	5
4. PLC configuration.....	11
5. Ground fault protection.....	11
6. Operation	12
7. Modbus registers	13
8. Network design	22
9. Specifications	24

Compatibility

This manual is suitable for:

- Modbus TCP Card
- Modbus TCP Card with Ground Fault

These cards are suitable for use with EMX4e and EMX4i soft starters.

The available features may vary according to the model and version of the starter.

This user manual is intended for use with version 2.x of the Modbus TCP Card. Version 1.x of the Modbus TCP Card does not support custom users or IoT operation.

© 2021 AuCom Electronics Ltd. All Rights Reserved.

Disclaimer

The examples and diagrams in this manual are included solely for illustrative purposes. The information contained in this manual is subject to change at any time and without prior notice. In no event will responsibility or liability be accepted for direct, indirect or consequential damages resulting from the use or application of this equipment.

Failure to follow the information and instructions in this manual will void the warranty.

Warnings

It is the installer's responsibility to follow all instructions in this manual and to follow correct electrical practice.



WARNING

For your safety, isolate the soft starter completely from mains voltage before attaching or removing accessories.



WARNING

Inserting foreign objects or touching the inside of the starter while the expansion port cover is open may endanger personnel, and can damage the starter.

1. Introduction

1.1 Product design

The Modbus TCP Card allows the soft starter to connect to an Ethernet network and be controlled or monitored using an Ethernet communication model.

Familiarity with Ethernet protocols and networks is required to operate the device successfully. For difficulties using this device with third party products, including PLCs, scanners and commissioning tools, contact the relevant supplier.

1.2 Connections

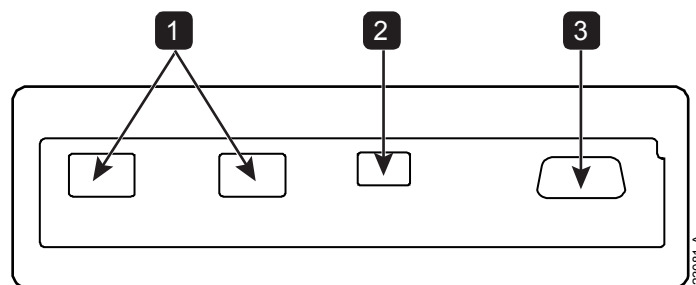

- | | |
|---|--|
| 1 | 2 x RJ45 ethernet ports, supporting line, star, ring and loop network topologies |
| 2 | 2 pin connector for ground fault CT (selected models) |
| 3 | DB9 connector for optional remote keypad |

1.3 Communication protocols

The Modbus TCP Card supports the following protocols:

Modbus TCP	Industrial ethernet via Modbus TCP
MQTT	Message Queue Telemetry Transport
OPC UA	Open Platform Communications Unified Architecture

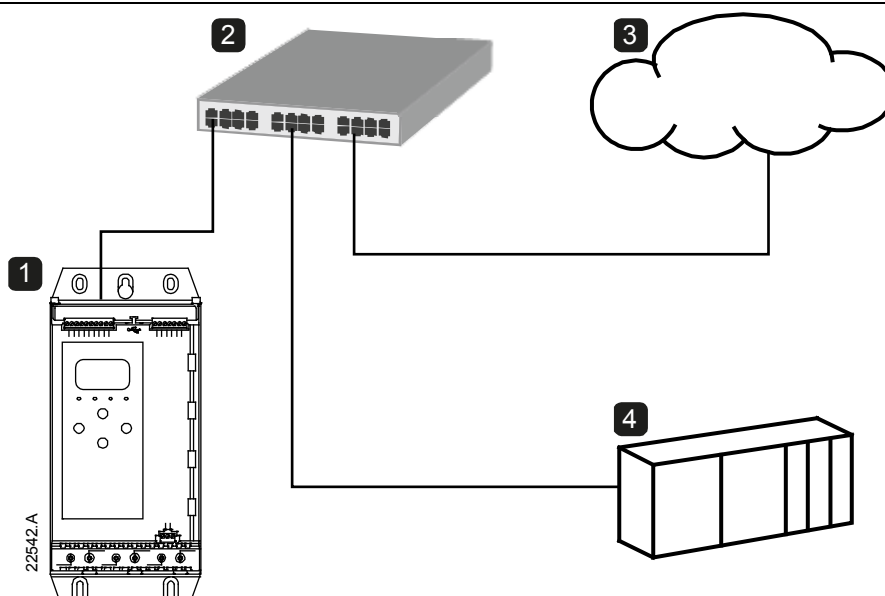

INSTRUCTIONS

- | | |
|---|---|
| 1 | Soft starter |
| 2 | Network switch |
| 3 | IoT connection (MQTT/OPC UA) |
| 4 | Industrial ethernet connection to programmable logic controller |
-

2. Installation

2.1 Installing the expansion card

1. Push a small flat-bladed screwdriver into the slot in the centre of the expansion port cover, and ease the cover away from the starter.
2. Line up the card with the expansion port. Gently push the card along the guide rails until it clicks into the starter.

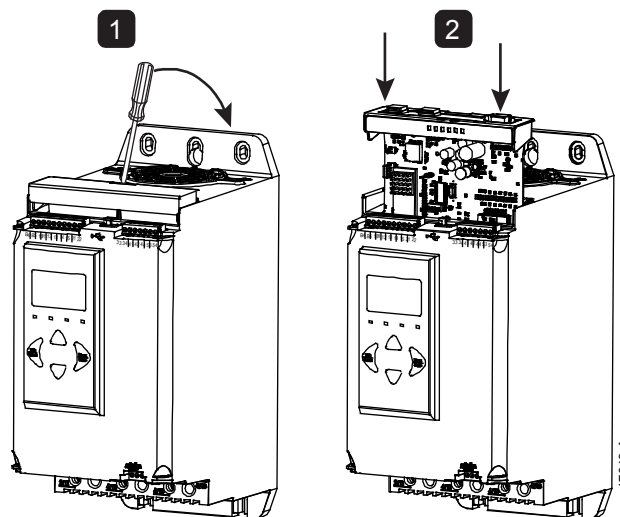

2.2 Network connection

Ethernet ports

The device has two Ethernet ports. If only one connection is required, either port can be used.

Cables

Use Category 5, 5e, 6 or 6e cable to connect to the device.

EMC precautions

To minimise electromagnetic interference, Ethernet cables should be separated from motor and mains cables by 200 mm.

If the Ethernet cable must cross motor or mains cables, the crossing should be at an angle of 90°.

2.3 Network establishment

The controller must establish communications directly with each device before the device can participate in the network.

2.4 Addressing

Each device in a network is addressed using a MAC address and an IP address.

- The device can be assigned a static IP address during configuration, or can be configured to accept a dynamic IP address (via DHCP).
- The MAC address is fixed within the device and is printed on a label on the front of the device.

3. Device configuration



NOTE

The Error LED flashes whenever the device is receiving power but is not connected to a network. The Error LED will flash occasionally during the configuration process.



NOTE

At power-up, the card loads the IP address stored in the soft starter.

3.1 Configuration methods

Network communication parameters for the card can be set via the soft starter or via the on-board web server.

- The card uses a static IP address by default. To enable DHCP addressing, set parameter 12T *DHCP* to 'Enable' or change the setting via the on-board web server.
- The IP address can be configured via the soft starter's programmable parameters.
- The web server can configure the IP address and messaging settings for MQTT or OPC UA operation.

3.2 Configure network settings via the starter

Use parameters 12H~12U to configure the network address.

Parameter	Parameter name	Default
12H	<i>Gateway Address</i>	192
12I	<i>Gateway Address 2</i>	168
12J	<i>Gateway Address 3</i>	0
12K	<i>Gateway Address 4</i>	100
12L	<i>IP Address</i>	192
12M	<i>IP Address 2</i>	168
12N	<i>IP Address 3</i>	0
12O	<i>IP Address 4</i>	2

INSTRUCTIONS

Parameter	Parameter name	Default
12P	<i>Subnet Mask</i>	255
12Q	<i>Subnet Mask 2</i>	255
12R	<i>Subnet Mask 3</i>	255
12S	<i>Subnet Mask 4</i>	0
12T	<i>DHCP</i>	Disable
12U	<i>Location ID</i>	0

3.3 Enabling network control

The soft starter will only accept commands from the Modbus TCP Card if parameter 1A *Command Source* is set to 'Network'.



NOTE

If the reset input is active, the starter will not operate. If a reset switch is not required, use parameter 7I to set the reset input to normally open or fit a link across terminals 10, 11 on the soft starter.

3.4 On-board web server

Connect to the device

To configure settings using the on-board web server, the card must be installed in a soft starter, control power must be available, and the card and computer must both be connected to the Ethernet network.

The computer must use a fixed IP address (not DHCP) and the same subnet mask as the card. The default IP address for the card is 192.168.0.2. The default subnet mask is 255.255.255.0.

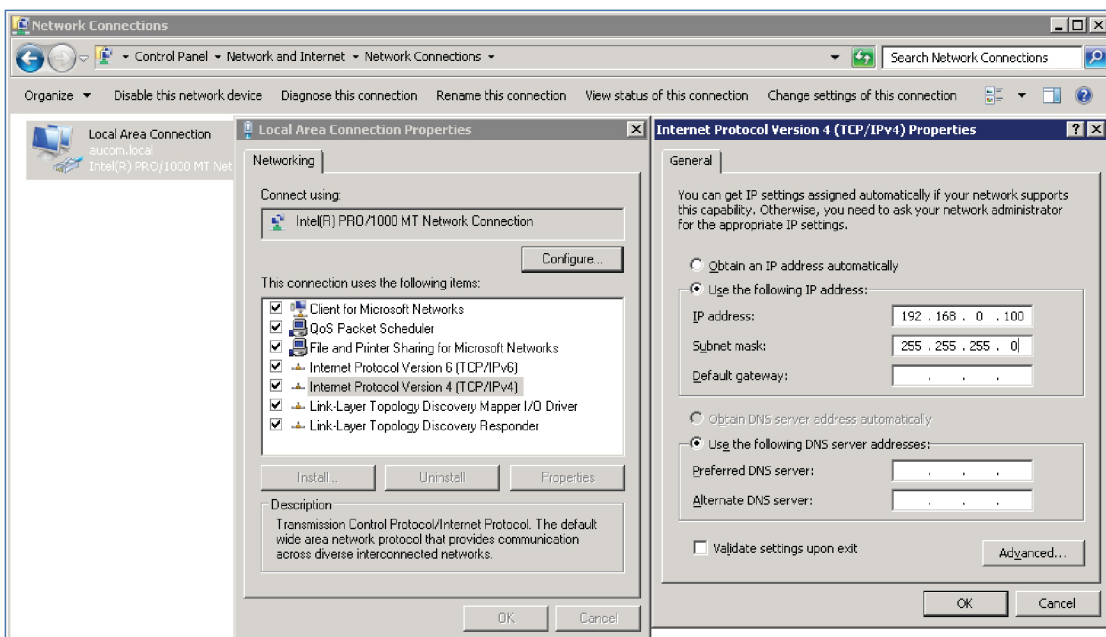

20543.A

Once connected, the web server reports basic information about the card and the soft starter.

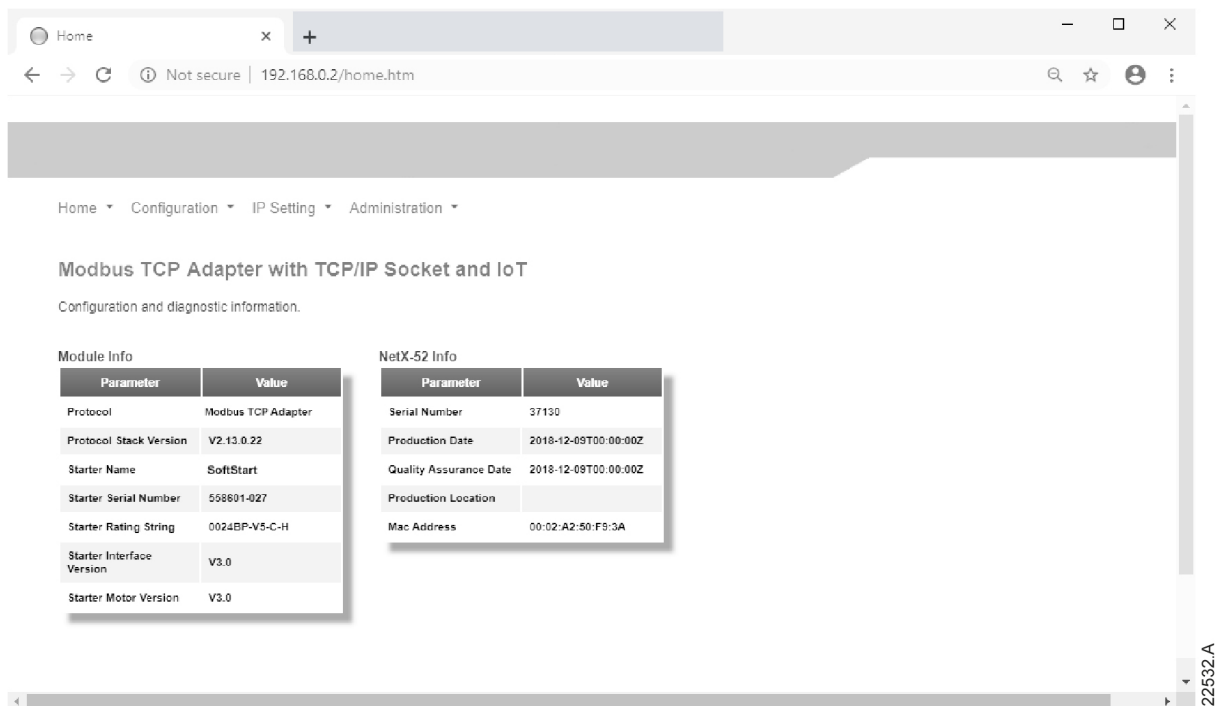

Manage users and passwords



NOTE

For security reasons, we recommend that you define a custom administrator ID and password.

The default username and password are:

username: admin

password: 1978



NOTE

Version 1.x of the Modbus TCP Card does not support custom users.

The Modbus TCP Card supports multiple users and levels of privilege.

- Users can view the home screen and IP address settings
- Supervisors can view the home screen and IP settings and can change configuration settings
- Administrators can view the home screen, change configuration settings and add or delete users

To add a new user:

1. Connect to the web server then click Administration.
2. Click Create new user.
3. Enter the new username and password then click Create an account.
4. Set privileges (user, supervisor, administrator) as appropriate.
5. Click Save changes.

INSTRUCTIONS

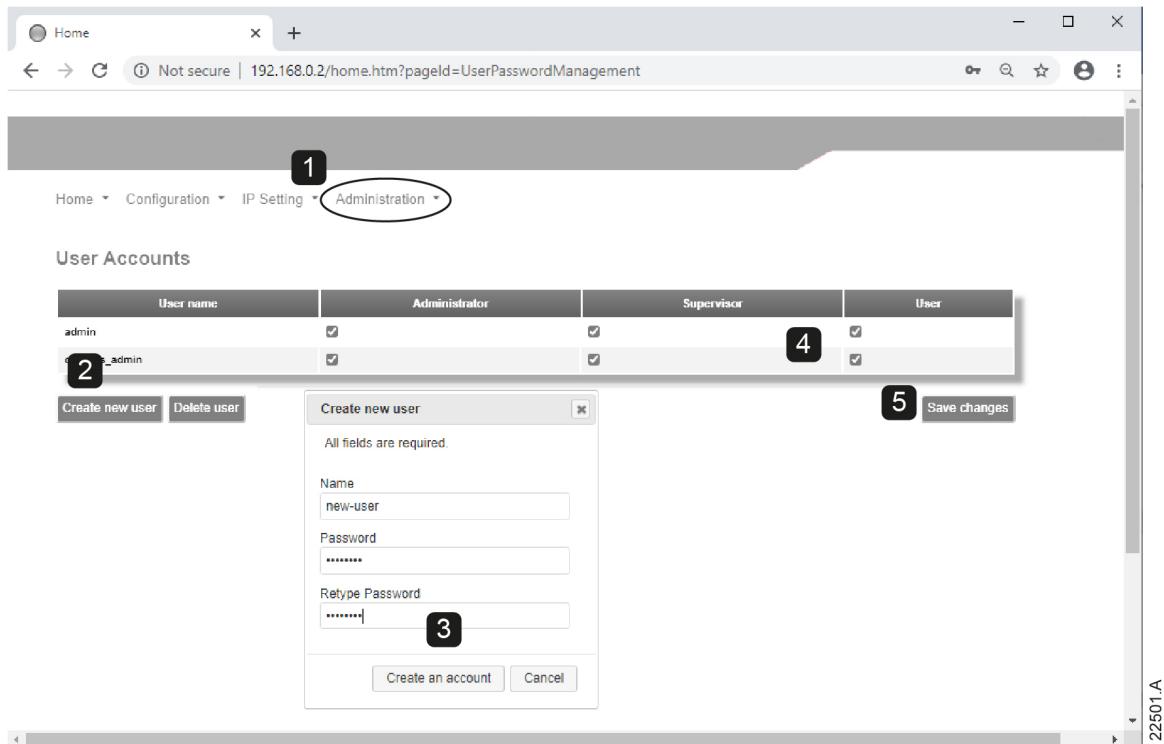

To delete a user:

1. Connect to the web server then click Administration.
2. Click the required entry in the user list then click Delete user. Click Delete again to confirm the action.

Configure the IP address



For version 1.x of the Modbus TCP Card, changes made via the web server are not stored in the soft starter and will be lost when control power is cycled.

1. Connect to the web server then click IP Setting.
2. Edit the settings as required. To enable DHCP addressing, tick the DHCP checkbox.
3. Click Submit to send the new settings to the device.



Configure IoT settings

The Modbus TCP Card supports soft starter status monitoring over IoT. The card cannot control or program the soft starter.



NOTE

Version 1.x of the Modbus TCP Card does not support IoT operation.

• Configure MQTT settings

1. Connect to the web server then click Configuration > MQTT Client.
2. Tick the Enable checkbox to enable MQTT client operation. The MQTT client is enabled by default.
3. Click Connection then configure the settings as required.
4. Use Connection > Actions to select which information the card will publish.
5. Click Submit to save all settings in the card.

Parameter	Value
Client ID	1
Broker address	192.168.0.100
Broker port	1883
Flags	Clean session <input checked="" type="checkbox"/> Reliable <input type="checkbox"/> Will <input type="checkbox"/> Prefix will <input checked="" type="checkbox"/> Secure <input type="checkbox"/> Verify Certificate <input type="checkbox"/>
Topic prefix	For:4000
User name	
Password	
Will topic	
Connection Timeout (s)	10
Connection idle timeout (s)	0
MQTT keep alive interval (s)	30

• Configure OPC UA settings

1. Connect to the web server then click Configuration > OPC UA Server.
2. Tick the Enable checkbox to enable OPC UA client operation. The OPC UA client is enabled by default.
3. Click Server Configuration then configure the settings as required.
4. Use Actions to select the actions for different object instances.
5. Click Submit to save all settings in the card.

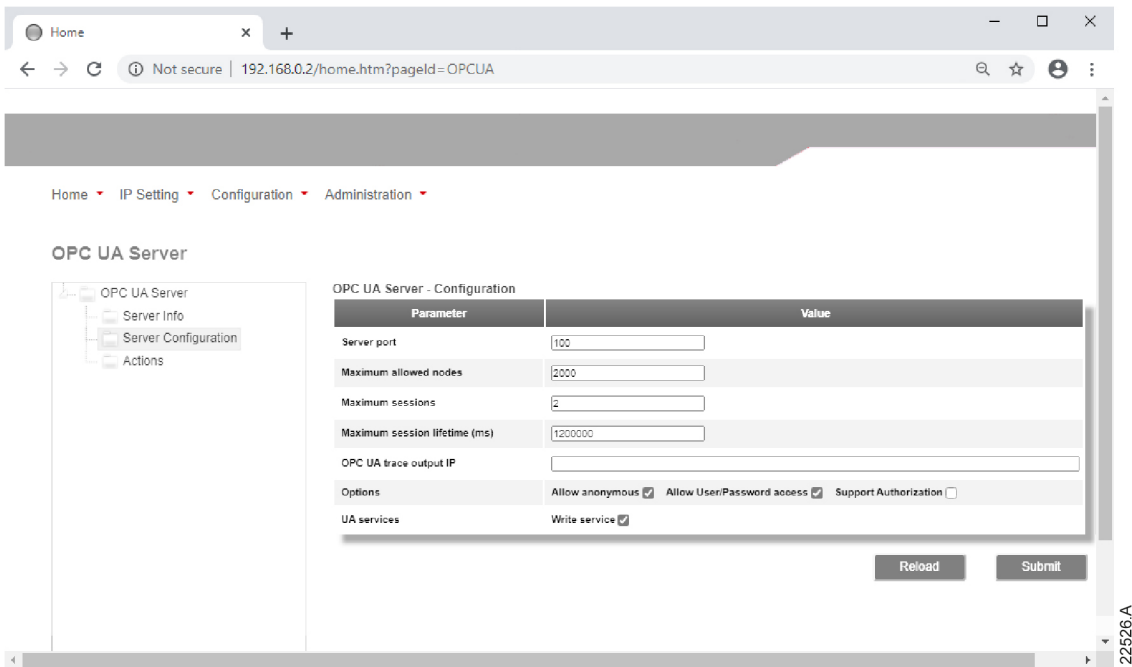

Scanning the network

If you cannot connect to the web server and cannot physically access the soft starter, use the Ethernet Device Configuration software to scan the network and identify the device. Changes made via the software cannot be stored permanently in the device and will be lost when control power is cycled.

The Ethernet Device Configuration Tool is available from your local supplier.



NOTE

If your PC has a firewall enabled, you must add the tool to the list of authorised programs.

To identify the device using the Ethernet Device Configuration Tool:

1. Start the Ethernet Device Configuration Tool.
2. Click on Search Devices. The software will search for connected devices.

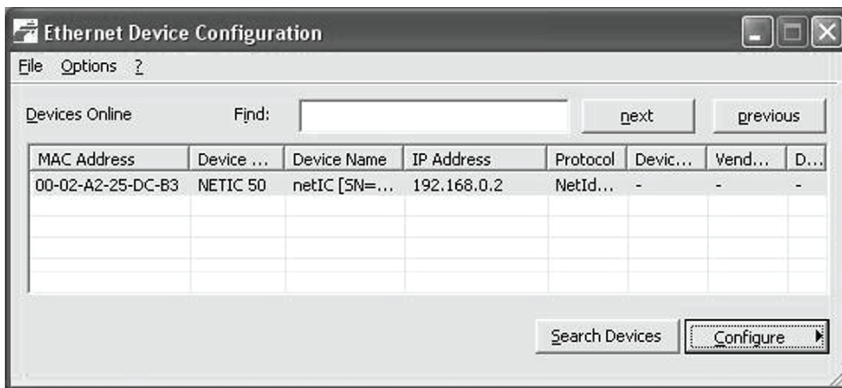

3. Use the IP address to connect to the device via the web server.

4. PLC configuration

The PLC must be configured to map registers within the device to addresses within the PLC.

The device must be configured directly in the PLC. No additional files are required.

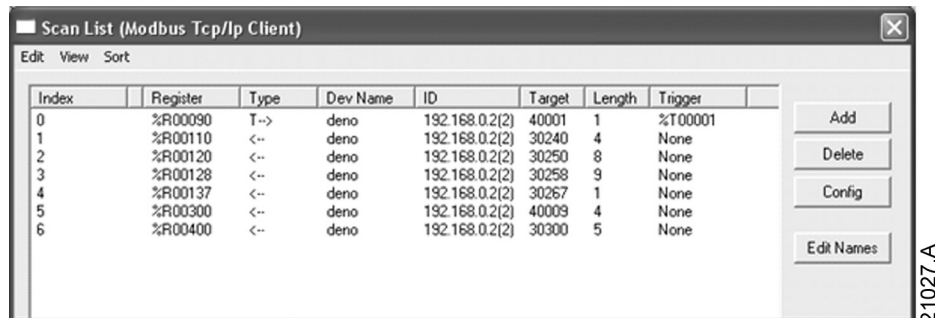

5. Ground fault protection



NOTE

Ground fault protection is only available on ground fault enabled cards, with soft starters running a compatible version of software. Contact your supplier for assistance.

5.1 Overview

The Modbus TCP Card can detect ground current and trip before the equipment is damaged.

Ground fault protection requires a 1000:1 or 2000:1 current transformer (not supplied). The CT should be rated 1 VA or 5 VA. The soft starter can be configured to trip at 1 A~50 A. If ground fault current rises above 50 A, the soft starter will trip immediately.

Parameter 40C *Ground Fault Trip Active* selects when ground fault protection is active.

5.2 Connect the CT to the ground fault inputs

To use ground fault protection, a common mode current transformer (CT) must be installed around all three phases. Use a 1000:1 or 2000:1 CT with rating of 1 VA or 5 VA and set parameter 40E *Ground Fault CT Ratio* to match. Connect the CT to the ground fault terminals (G1, G2, G3).

For maximum protection, the CT should be installed on the input side of the soft starter.

5.3 Configure ground fault protection settings

Ground fault protection settings must be set in the soft starter.

Parameter	Parameter name	Description
40A	<i>Ground Fault Level</i>	Sets the trip point for ground fault protection.
40B	<i>Ground Fault Delay</i>	Slows the Modbus TCP Card's response to ground fault variation, avoiding trips due to momentary fluctuations.
40C	<i>Ground Fault Trip Active</i>	Selects when a ground fault trip can occur.
40D	<i>Ground Fault Action</i>	Selects the soft starter's response to the protection event.
40E	<i>Ground Fault CT Ratio</i>	Set to match the ratio of the ground current measuring CT.

6. Operation

The Modbus TCP Card must be controlled by a Modbus client (such as a PLC) which complies with the Modbus Protocol Specification. For successful operation, the client must also support all functions and interfaces described in this document.



NOTE

The available features and parameter details may vary according to the model and software version of the starter. Refer to the soft starter user manual for details of parameters and supported features.

6.1 Device classification

The Modbus TCP Card is a Modbus server and must be managed by a Modbus client over Ethernet.

6.2 Ensuring safe and successful control

Data written to the device will remain in its registers until the data is overwritten or the device is reinitialised.

If the soft starter may be controlled via Command Override (parameter 7A) or may be disabled via the reset input (terminals 10, 11) fieldbus commands should be cleared from the registers. If a command is not cleared, it will be re-sent to the starter once fieldbus control resumes.

6.3 Feedback LEDs

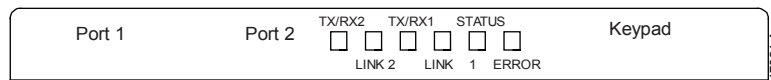

LED name	LED state	Description
Error	Off	No error.
	Flashing	System error.
	On	Communication error.
Status	Off	Device is not powered up.
	Slow flash	Ready but not configured.
	Fast flash	Communication has been established.
Link x	Off	No network connection.
	On	Connected to a network.
TX/RX x	Flashing	Operating normally.
	Off	No network connection.

7. Modbus registers



NOTE

The available features and parameter details may vary according to the model and software version of the starter. Refer to the soft starter user manual for details of parameters and supported features.



NOTE

All references to registers mean the registers within the card unless otherwise stated.

7.1 Command and configuration registers (read/write)

Register	Description	Bits	Details
40001	Command (single write)	0 to 7	To send a command to the starter, write the required value: 00000000 = Stop 00000001 = Start 00000010 = Reset 00000100 = Quick stop (coast to stop) 00001000 = Forced communication trip 00010000 = Start using Parameter Set 1 00100000 = Start using Parameter Set 2 01000000 = <i>Reserved</i> 10000000 = <i>Reserved</i>
		8 to 14	<i>Reserved</i>
		15	Must = 1

INSTRUCTIONS

Register	Description	Bits	Details
40002 ~ 40008	<i>Reserved</i>		
40009 ~ 40xxx	Parameter management (single/multiple read or multiple write)	0 to 15	Manage soft starter programmable parameters.

7.2 Parameter management

Parameters can be read from and written to the starter. When writing parameters to the soft starter, every parameter will be updated to match the values in the PLC.



NOTE

While parameters are being written, the starter cannot start/stop the motor.

The Modbus TCP protocol limits read/write operations to a maximum of 123 registers at one time. The registers must be consecutive.

To avoid loss of communications due to an unintentional change of network configuration, write the network address parameter settings before writing start/stop parameter settings.

When writing parameters to the soft starter, we recommend the following procedure:

1. Configure all soft starter parameter values in the PLC as required, including IP address, Gateway Address, Subnet Mask and DHCP configuration.
2. Write the parameter block that includes the network parameter settings from the PLC to the soft starter.
3. Write the other parameter blocks from the PLC to the starter until all parameter values have been written.



NOTE

For reliable operation, the parameter block containing network configuration settings must be written first.

7.3 Status reporting registers (read only)

Register	Description	Bits	Details
30003 ~ 30008	<i>Reserved</i>		
30600	Product information	0 to 5 6 to 8 9 to 15	Binary protocol version <i>Reserved</i> Product type code: 12 = EMX4e 13 = EMX4i
30601	Model number	0 to 7 8 to 15	<i>Reserved</i> Soft starter model ID

Register	Description	Bits	Details
30602	<i>Reserved</i>		
30603	<i>Reserved</i>		
30604	Starter state	0 to 4	0 = <i>Reserved</i> 1 = Ready 2 = Starting 3 = Running 4 = Stopping 5 = Not ready (restart delay, restart temperature check, run simulation, reset input is open) 6 = Tripped 7 = Programming mode 8 = Jog forward 9 = Jog reverse
		5	1 = Warning
		6	0 = Uninitialised 1 = Initialised
		7	Command source 0 = Remote Keypad, Digital Input, Clock 1 = Network
		8	<i>Reserved</i>
		9	0 = Negative phase sequence 1 = Positive phase sequence
		10 to 15	<i>Reserved</i>
30605	Current	0 to 13	Average rms current across all three phases
		14 to 15	<i>Reserved</i>
30606	Current	0 to 9	Current (% motor FLC)
		10 to 15	<i>Reserved</i>
30607	Motor temperature	0 to 7	Motor thermal model (%)
		8 to 15	<i>Reserved</i>
30608	Power	0 to 11	Power
		12 to 13	Power scale 0 = Multiply power by 10 to get W 1 = Multiply power by 100 to get W 2 = Power (kW) 3 = Multiply power by 10 to get kW
		14 to 15	<i>Reserved</i>
30609	% Power factor	0 to 7	100% = power factor of 1
		8 to 15	<i>Reserved</i>
30610	Voltage	0 to 13	Average rms voltage across all three phases
		14 to 15	<i>Reserved</i>

INSTRUCTIONS

Register	Description	Bits	Details
30611	Current	0 to 13	Phase 1 current (rms)
		14 to 15	<i>Reserved</i>
30612	Current	0 to 13	Phase 2 current (rms)
		14 to 15	<i>Reserved</i>
30613	Current	0 to 13	Phase 3 current (rms)
		14 to 15	<i>Reserved</i>
30614	Voltage	0 to 13	Phase 1 voltage
		14 to 15	<i>Reserved</i>
30615	Voltage	0 to 13	Phase 2 voltage
		14 to 15	<i>Reserved</i>
30616	Voltage	0 to 13	Phase 3 voltage
		14 to 15	<i>Reserved</i>
30617	Parameter list version number	0 to 7	Parameter list minor revision
		8 to 15	Parameter list major version
30618	Digital input state	0 to 15	For all inputs, 0 = open, 1 = closed (shorted) 0 = Start/Stop 1 = <i>Reserved</i> 2 = Reset 3 = Input A 4 = Input B 5 to 15 = <i>Reserved</i>
30619	Trip code	0 to 7	Refer to Trip codes on page 20
		8 to 15	<i>Reserved</i>
30620	<i>Reserved</i>		
30621	Frequency	0 to 15	Frequency (Hz)
30622	Ground current	0 to 15	Ground current (A)
30623~ 30631	<i>Reserved</i>		



NOTE

The reset input is normally closed by default. If parameter 71 *Reset/Enable Logic* is set to normally open, the reported state will be inverted (0 = closed, 1 = open).



NOTE

For models EMX4x-0064B and smaller, current reported via communications is 10 times greater than the actual value (displayed on the keypad).



NOTE

Frequency reported via communications is 10 times greater than the actual value (displayed on the keypad).

7.4 Legacy mode

The Modbus TCP Card can also operate in Legacy Mode, which uses the same registers as the clip-on Modbus RTU Module, supplied by AuCom for use with older soft starters. Some registers differ from those specified in the Modbus Protocol Specification.

Initialising Legacy Mode

If the card has been operating in Standard Mode, it must be reset before communicating in Legacy Mode. To initialise the card for Legacy Mode, either:

- cycle control power or
- reset register 40001 to zero (write zero to bits 0~15)

Registers



NOTE

Legacy Mode reports read-only status information in registers 40003 onwards, to match the register definitions of the clip-on Modbus Module for use with older soft starters. Identical data is also available via registers 30003 onwards.

Register	Description	Bits	Details
40001	<i>Reserved</i>		
40002	Command (single write)	0 to 2	To send a command to the starter, write the required value: 1 = Start 2 = Stop 3 = Reset 4 = Quick stop (coast to stop) 5 = Forced communication trip 6 = Start using Parameter Set 1 7 = Start using Parameter Set 2
		3 to 15	<i>Reserved</i>
40003	Starter state	0 to 3	1 = Ready 2 = Starting 3 = Running 4 = Stopping (including braking) 5 = Restart delay (including temperature check) 6 = Tripped 7 = Programming mode 8 = Jog forward 9 = Jog reverse
		4	1 = Positive phase sequence (only valid if bit 6 = 1)
		5	1 = Current exceeds FLC

INSTRUCTIONS

Register	Description	Bits	Details
		6	0 = Uninitialised 1 = Initialised
		7 to 15	<i>Reserved</i>
40004	<i>Reserved</i>		
40005	Motor current	0 to 7	Average rms current across all three phases
		8 to 15	<i>Reserved</i>
40006	Motor temperature	0 to 7	Motor thermal model (%)
		8 to 15	<i>Reserved</i>
40007	<i>Reserved</i>		
40008	<i>Reserved</i>		
40009 ~ 40xxx	Parameter management (single/multiple read or multiple write)	0 to 7	Manage soft starter programmable parameters. Refer to the relevant soft starter literature for a complete parameter list.
		8 to 15	<i>Reserved</i>
40600	Product information	0 to 5	Binary protocol version
		6 to 8	<i>Reserved</i>
		9 to 15	Product type code: 12 = EMX4e 13 = EMX4i
40601	Model number	0 to 7	<i>Reserved</i>
		8 to 15	Soft starter model ID
40602	<i>Reserved</i>		
40603	<i>Reserved</i>		
40604	Starter state	0 to 4	0 = <i>Reserved</i> 1 = Ready 2 = Starting 3 = Running 4 = Stopping 5 = Not ready (restart delay, restart temperature check, run simulation, reset input is open) 6 = Tripped 7 = Programming mode 8 = Jog forward 9 = Jog reverse
		5	1 = Warning
		6	0 = Uninitialised 1 = Initialised

Register	Description	Bits	Details
		7	Command source 0 = Remote Keypad, Digital Input, Clock 1 = Network
		8	<i>Reserved</i>
		9	0 = Negative phase sequence 1 = Positive phase sequence
		10 to 15	<i>Reserved</i>
40605	Current	0 to 13	Average rms current across all three phases
		14 to 15	<i>Reserved</i>
40606	Current	0 to 9	Current (% motor FLC)
		10 to 15	<i>Reserved</i>
40607	Motor temperature	0 to 7	Motor thermal model (%)
		8 to 15	<i>Reserved</i>
40608	Power	0 to 11	Power
		12 to 13	Power scale 0 = Multiply power by 10 to get W 1 = Multiply power by 100 to get W 2 = Power (kW) 3 = Multiply power by 10 to get kW
		14 to 15	<i>Reserved</i>
40609	% Power factor	0 to 7	100% = power factor of 1
		8 to 15	<i>Reserved</i>
40610	Voltage	0 to 13	Average rms voltage across all three phases
		14 to 15	<i>Reserved</i>
40611	Current	0 to 13	Phase 1 current (rms)
		14 to 15	<i>Reserved</i>
40612	Current	0 to 13	Phase 2 current (rms)
		14 to 15	<i>Reserved</i>
40613	Current	0 to 13	Phase 3 current (rms)
		14 to 15	<i>Reserved</i>
40614	Voltage	0 to 13	Phase 1 voltage
		14 to 15	<i>Reserved</i>
40615	Voltage	0 to 13	Phase 2 voltage
		14 to 15	<i>Reserved</i>
40616	Voltage	0 to 13	Phase 3 voltage
		14 to 15	<i>Reserved</i>
40617	Parameter list	0 to 7	Parameter list minor revision
	version number	8 to 15	Parameter list major version

INSTRUCTIONS

Register	Description	Bits	Details
40618	Digital input state	0 to 15	For all inputs, 0 = open, 1 = closed (shorted) 0 = Start/Stop 1 = <i>Reserved</i> 2 = Reset 3 = Input A 4 = Input B 5 to 15 = <i>Reserved</i>
40619	Trip code	0 to 7 8 to 15	Refer to Trip codes on page 20 <i>Reserved</i>
40620~ 40631	<i>Reserved</i>		



NOTE

The reset input is normally closed by default. If parameter 71 *Reset/Enable Logic* is set to normally open, the reported state will be inverted (0 = closed, 1 = open).



NOTE

For models EMX4x-0064B and smaller, current reported via communications is 10 times greater than the actual value (displayed on the keypad).

7.5 Trip codes

Trip code	Description
255	No trip
1	Excess start time
2	Motor overload
3	Motor thermistor
4	Current imbalance
5	Frequency
6	Phase sequence
7	Overcurrent
8	Power loss
9	Undercurrent
10	Heatsink overtemperature
11	Motor connection
12	Input A trip
13	FLC too high
14	Unsupported option (function not available in inside delta)
15	Communications card fault
16	Network communication
18	Overvoltage

Trip code	Description
19	Undervoltage
20	Ground fault
23	Parameter out of range
24	Input B trip
26	L1 phase loss
27	L2 phase loss
28	L3 phase loss
29	L1-T1 shorted
30	L2-T2 shorted
31	L3-T3 shorted
33	Time-overcurrent (Bypass overload)
34	SCR overtemperature
35	Battery/clock
36	Thermistor circuit
47	Overpower
48	Underpower
56	Keypad disconnected
57	Zero Speed Detect
58	SCR Itsm
59	Instantaneous overcurrent
60	Rating Capacity
70	Current Read Err L1
71	Current Read Err L2
72	Current Read Err L3
74	Motor Connection T1
75	Motor Connection T2
76	Motor Connection T3
77	Firing Fail P1
78	Firing Fail P2
79	Firing Fail P3
80	VZC Fail P1
81	VZC Fail P2
82	VZC Fail P3
83	Low Control Volts
84~96	Internal fault x. Contact your local supplier with the fault code (X).

8. Network design

The device supports star, line and ring topologies.

8.1 Star topology

In a star network, all controllers and devices connect to a central network switch.

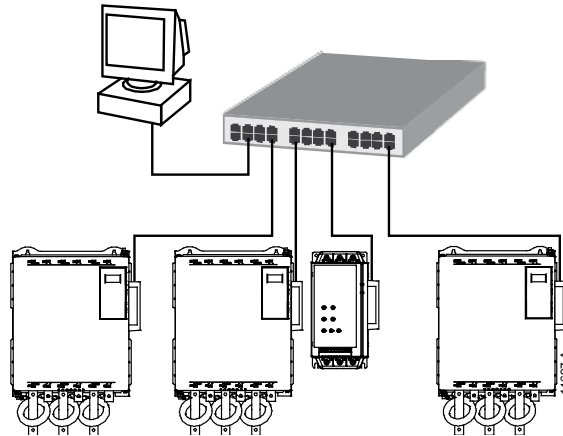

8.2 Line topology

In a line network, the controller connects directly to one port of the first device. The second Ethernet port connects to another device, which in turn connects to another device until all devices are connected.

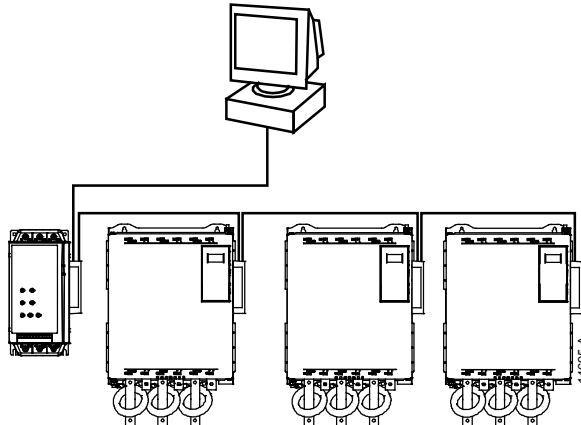

NOTE

The device has an integrated switch to allow data to pass through in line topology. The device must be receiving control power from the soft starter for the switch to operate.



NOTE

If the connection between two devices is interrupted, the controller cannot communicate with devices after the interruption point.



NOTE

Each connection adds a delay to communication with the next device. The maximum number of devices in a line network is 32. Exceeding this number may reduce the reliability of the network.

8.3 Ring Topology

In a ring topology network, the controller connects to the first card, via a network switch. The second Ethernet port of the card connects to another device, which in turn connects to another device until all devices are connected. The final device connects back to the switch.

The device supports beacon based ring node configuration.

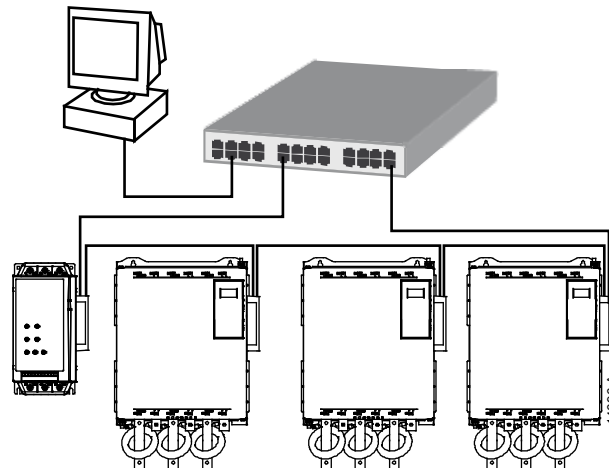

NOTE

The network switch must support loss of line detection.

8.4 Combined topologies

A single network can include both star and line components.

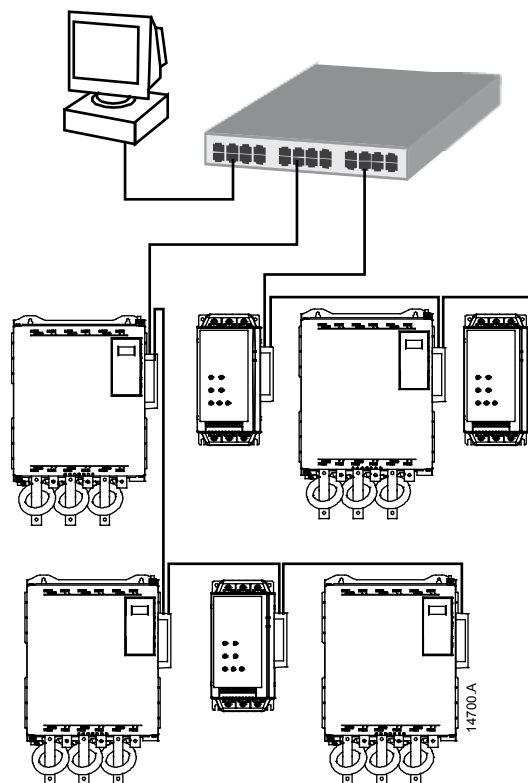

9. Specifications

- **Connections**

Soft starter 6-way pin assembly
Contacts Gold flash
Network RJ45

- **Settings**

IP address Automatically assigned, configurable
Device name Automatically assigned, configurable

- **Network**

Protocols Ethernet/IP, MQTT, OPC UA
..... DHCP, ACD (address conflict detection)
Link speed 10 Mbps, 100 Mbps (auto-detect)
Full duplex
Auto crossover

- **Power**

Consumption (steady state, maximum) 35 mA @ 24 VDC
Reverse polarity protected
Galvanically isolated

- **Certification**

RCM IEC 60947-4-2
CE EN 60947-4-2

