

## INSTRUCTIONS

# ETHERNET/IP CARD

RIGHT FROM  
THE START

**AuCom**  
MOTOR CONTROL SPECIALISTS

## Contents

1. Introduction .....	3
2. Installation.....	4
3. Device configuration.....	5
4. Scanner configuration.....	11
5. Ground fault protection.....	12
6. Operation .....	13
7. Implicit messaging (cyclic operation) .....	14
8. Explicit messaging (acyclic operation).....	16
9. Attributes.....	20
10. Network Design.....	22
11. Specifications .....	24

## Compatibility

This manual is suitable for use with:

- Ethernet/IP Card
- Ethernet/IP Card with Ground Fault

These cards are suitable for use with EMX4e and EMX4i soft starters.

The available features may vary according to the model and version of the starter.

This user manual is intended for use with version 2.x of the Ethernet/IP card. Version 1.x of the Ethernet/IP card does not support custom users or IoT operation.

© 2021 AuCom Electronics Ltd. All Rights Reserved.

# Disclaimer

The examples and diagrams in this manual are included solely for illustrative purposes. The information contained in this manual is subject to change at any time and without prior notice. In no event will responsibility or liability be accepted for direct, indirect or consequential damages resulting from the use or application of this equipment.

Failure to follow the information and instructions in this manual will void the warranty.

# Warnings

It is the installer's responsibility to follow all instructions in this manual and to follow correct electrical practice.



### WARNING

For your safety, isolate the soft starter completely from mains voltage before attaching or removing accessories.



### WARNING

Inserting foreign objects or touching the inside of the starter while the expansion port cover is open may endanger personnel, and can damage the starter.

# 1. Introduction

## 1.1 Product design

The Ethernet/IP Card allows the soft starter to connect to an Ethernet network and be controlled or monitored using an Ethernet communication model.

Familiarity with Ethernet protocols and networks is required to operate the device successfully. For difficulties using this device with third party products, including PLCs, scanners and commissioning tools, contact the relevant supplier.

## 1.2 Connections

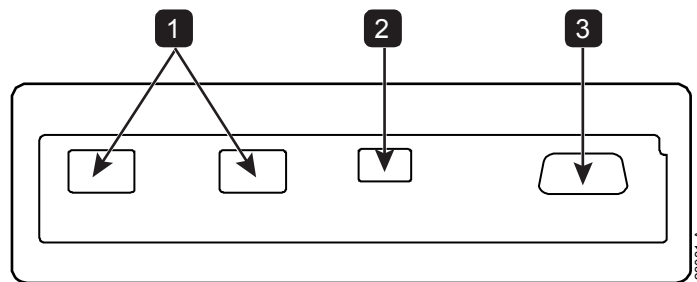

1	2 x RJ45 ethernet ports, supporting line, star, ring and loop network topologies
2	2 pin connector for ground fault CT (selected models)
3	DB9 connector for optional remote keypad

## 1.3 Communication protocols

The Ethernet/IP Card supports the following protocols:

Ethernet/IP	Industrial ethernet via Ethernet/IP
MQTT	Message Queue Telemetry Transport
OPC UA	Open Platform Communications Unified Architecture

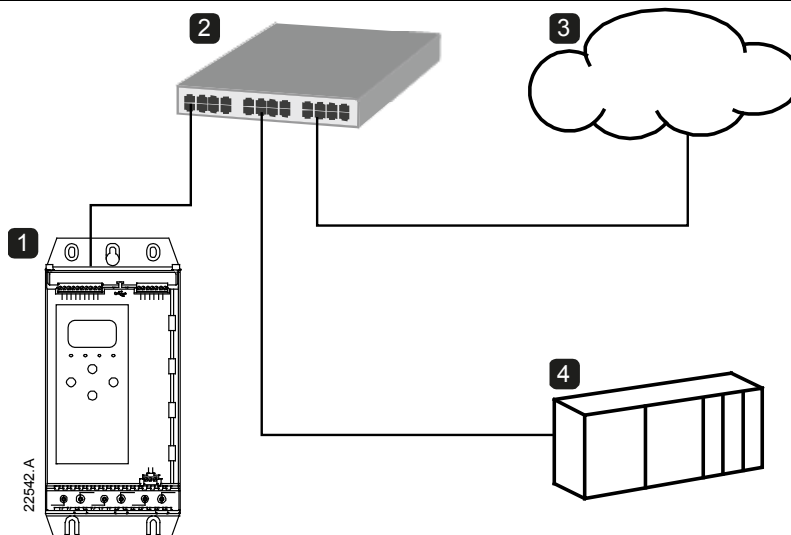

## INSTRUCTIONS

1	Soft starter
2	Network switch
3	IoT connection (MQTT/OPC UA)
4	Industrial ethernet connection to programmable logic controller

## 2. Installation

### 2.1 Installing the expansion card

1. Push a small flat-bladed screwdriver into the slot in the centre of the expansion port cover, and ease the cover away from the starter.
2. Line up the card with the expansion port. Gently push the card along the guide rails until it clicks into the starter.

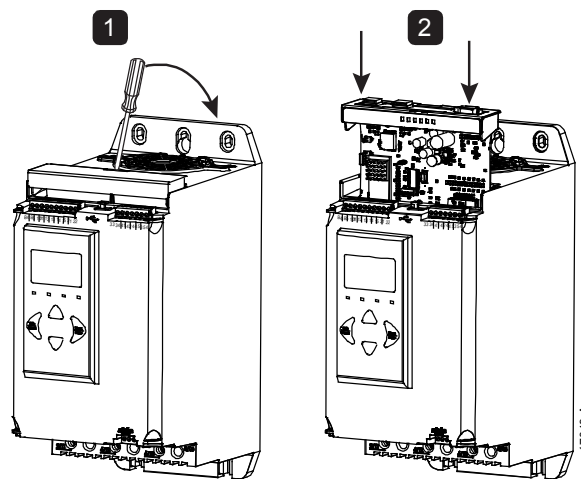

### 2.2 Network connection

#### Ethernet ports

The device has two Ethernet ports. If only one connection is required, either port can be used.

#### Cables

Use Category 5, 5e, 6 or 6e cable to connect to the device.

#### EMC precautions

To minimise electromagnetic interference, Ethernet cables should be separated from motor and mains cables by 200 mm.

If the Ethernet cable must cross motor or mains cables, the crossing should be at an angle of 90°.

### 2.3 Network establishment

The controller must establish communications directly with each device before the device can participate in the network.

## 2.4 Addressing

Each device in a network is addressed using a MAC address and an IP address.

- The device can be assigned a static IP address during configuration, or can be configured to accept a dynamic IP address (via DHCP).
- The MAC address is fixed within the device and is printed on a label on the front of the device.

## 3. Device configuration



### NOTE

The Error LED flashes whenever the device is receiving power but is not connected to a network. The Error LED will flash occasionally during the configuration process.



### NOTE

At power-up, the card loads the IP address stored in the soft starter.

### 3.1 Configuration methods

Network communication parameters for the card can be set via the soft starter or via the on-board web server.

- The card uses a static IP address by default. To enable DHCP addressing, set parameter 12T *DHCP* to 'Enable' or change the setting via the on-board web server.
- The IP address can be configured via the soft starter's programmable parameters.
- The web server can configure the IP address and messaging settings for MQTT or OPC UA operation.

### 3.2 Configure network settings via the starter

Use parameters 12H~12U to configure the network address. The parameters can be set via the Main Menu, via the Setup Tools, or by uploading a configuration file via USB Save & Load.

Parameter	Parameter name	Default
12H	<i>Gateway Address</i>	192
12I	<i>Gateway Address 2</i>	168
12J	<i>Gateway Address 3</i>	0
12K	<i>Gateway Address 4</i>	100
12L	<i>IP Address</i>	192
12M	<i>IP Address 2</i>	168
12N	<i>IP Address 3</i>	0
12O	<i>IP Address 4</i>	2
12P	<i>Subnet Mask</i>	255
12Q	<i>Subnet Mask 2</i>	255
12R	<i>Subnet Mask 3</i>	255

## INSTRUCTIONS

Parameter	Parameter name	Default
12S	<i>Subnet Mask 4</i>	0
12T	<i>DHCP</i>	Disable
12U	<i>Location ID</i>	0

### 3.3 Enabling Network Control

The soft starter will only accept commands from the Ethernet/IP Card if parameter 1A *Command Source* is set to 'Network'.



#### NOTE

If the reset input is active, the starter will not operate. If a reset switch is not required, use parameter 7I to set the reset input to normally open or fit a link across terminals 10, 11 on the soft starter.

### 3.4 On-board web server

#### Connect to the device

To configure settings using the on-board web server, the card must be installed in a soft starter, control power must be available, and the card and computer must both be connected to the Ethernet network.

The computer must use a fixed IP address (not DHCP) and the same subnet mask as the card. The default IP address for the card is 192.168.0.2. The default subnet mask is 255.255.255.0.

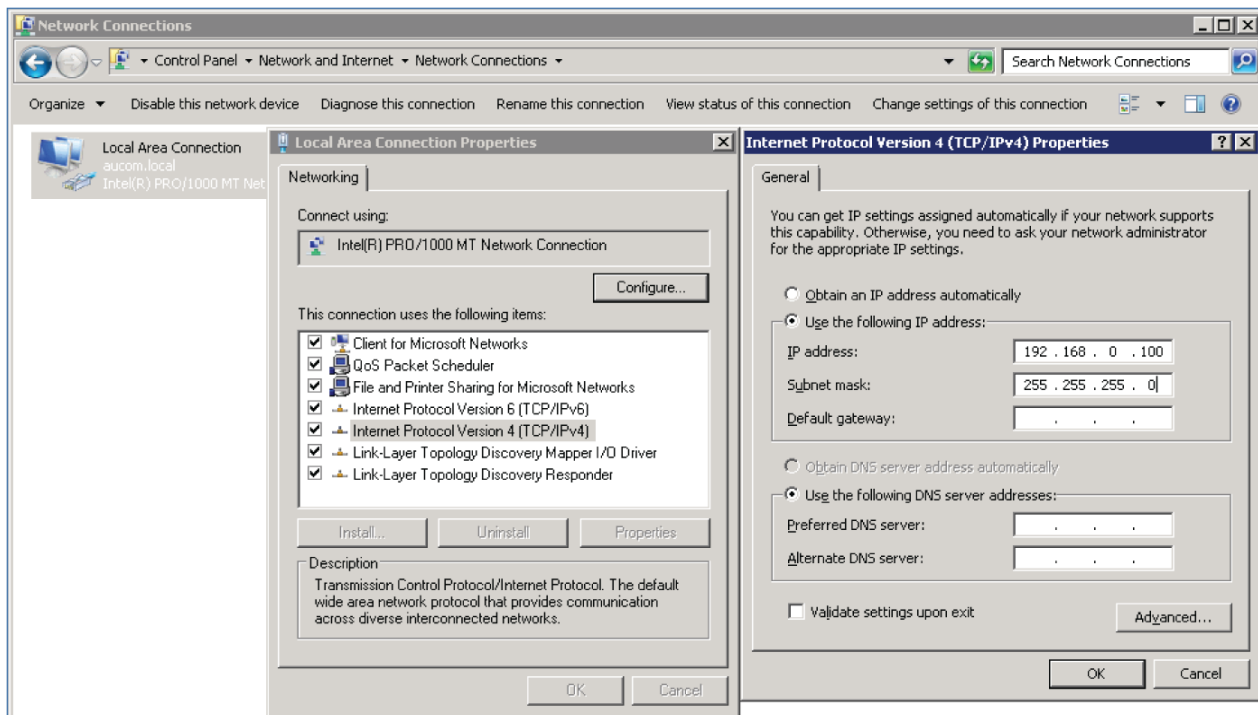

20543A

Once connected, the web server reports basic information about the card and the soft starter.

Home Configuration IP Setting Administration

### EtherNet/IP Adapter with TCP/IP Socket and IoT

Configuration and diagnostic information.

Parameter	Value
Protocol	EtherNet/IP Adapter
Protocol Stack Version	V2.13.0.22
Starter Name	SoftStart
Starter Serial Number	558601-027
Starter Rating String	0024BP-V5-C-H
Starter Interface Version	V3.0
Starter Motor Version	V3.0

Parameter	Value
Serial Number	37130
Production Date	2018-12-09T00:00:00Z
Quality Assurance Date	2018-12-09T00:00:00Z
Production Location	
Mac Address	00:02:A2:50:F9:3A

## Manage users and passwords



### NOTE

For security reasons, we recommend that you define a custom administrator ID and password.

The default username and password are:

username: admin

password: 1978



### NOTE

Version 1.x of the Ethernet/IP Card does not support custom users.

The Ethernet/IP Card supports multiple users and levels of privilege.

- Users can view the home screen and IP address settings
- Supervisors can view the home screen and IP settings and can change configuration settings
- Administrators can view the home screen, change configuration settings and add or delete users

## INSTRUCTIONS

To add a new user:

1. Connect to the web server then click Administration.
2. Click Create new user.
3. Enter the new username and password then click Create an account.
4. Set privileges (user, supervisor, administrator) as appropriate.
5. Click Save changes.

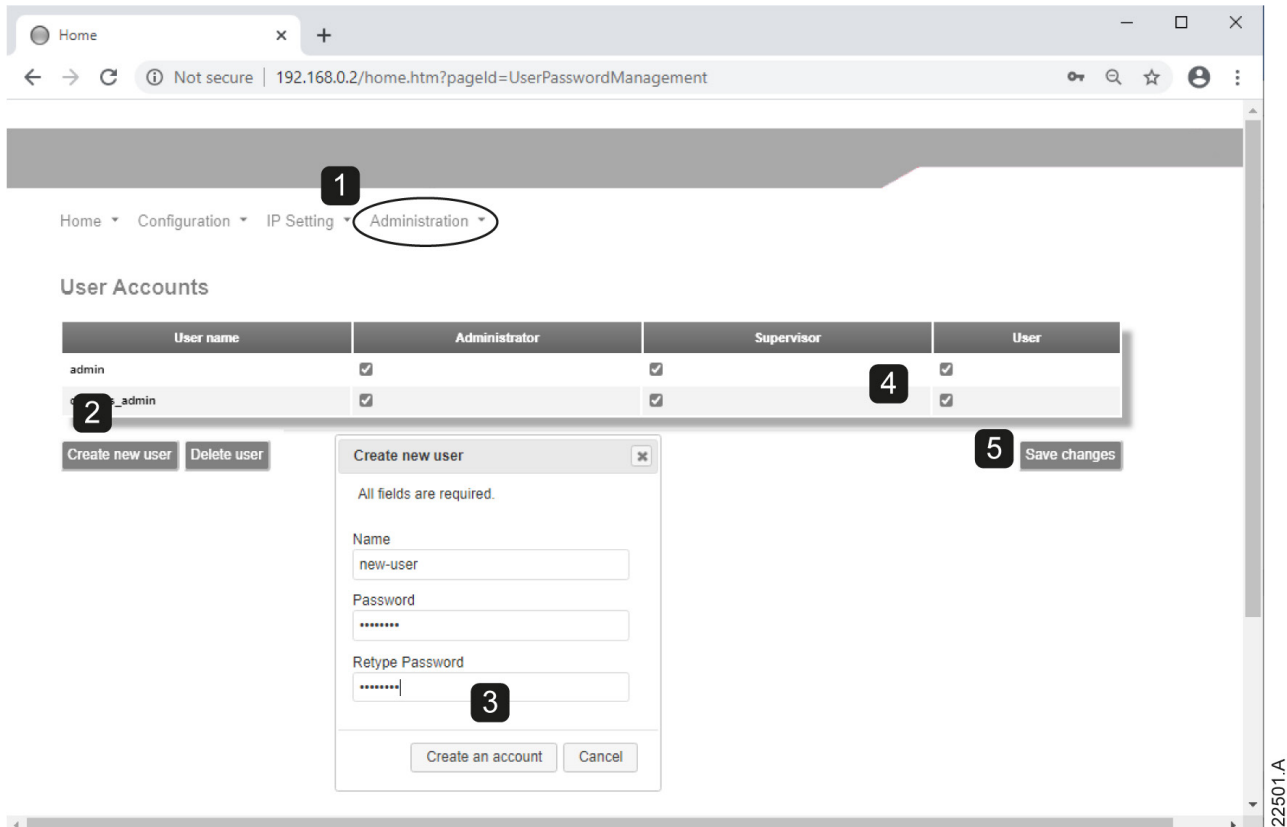

To delete a user:

1. Connect to the web server then click Administration.
2. Click the required entry in the user list then click Delete user. Click Delete again to confirm the action.



## Configure the IP address



### NOTE

For version 1.x of the Ethernet/IP Card, changes made via the web server are not stored in the soft starter and will be lost when control power is cycled.

1. Connect to the web server then click IP Setting.
2. Edit the settings as required. To enable DHCP addressing, tick the DHCP checkbox.
3. Click Submit to send the new settings to the device.

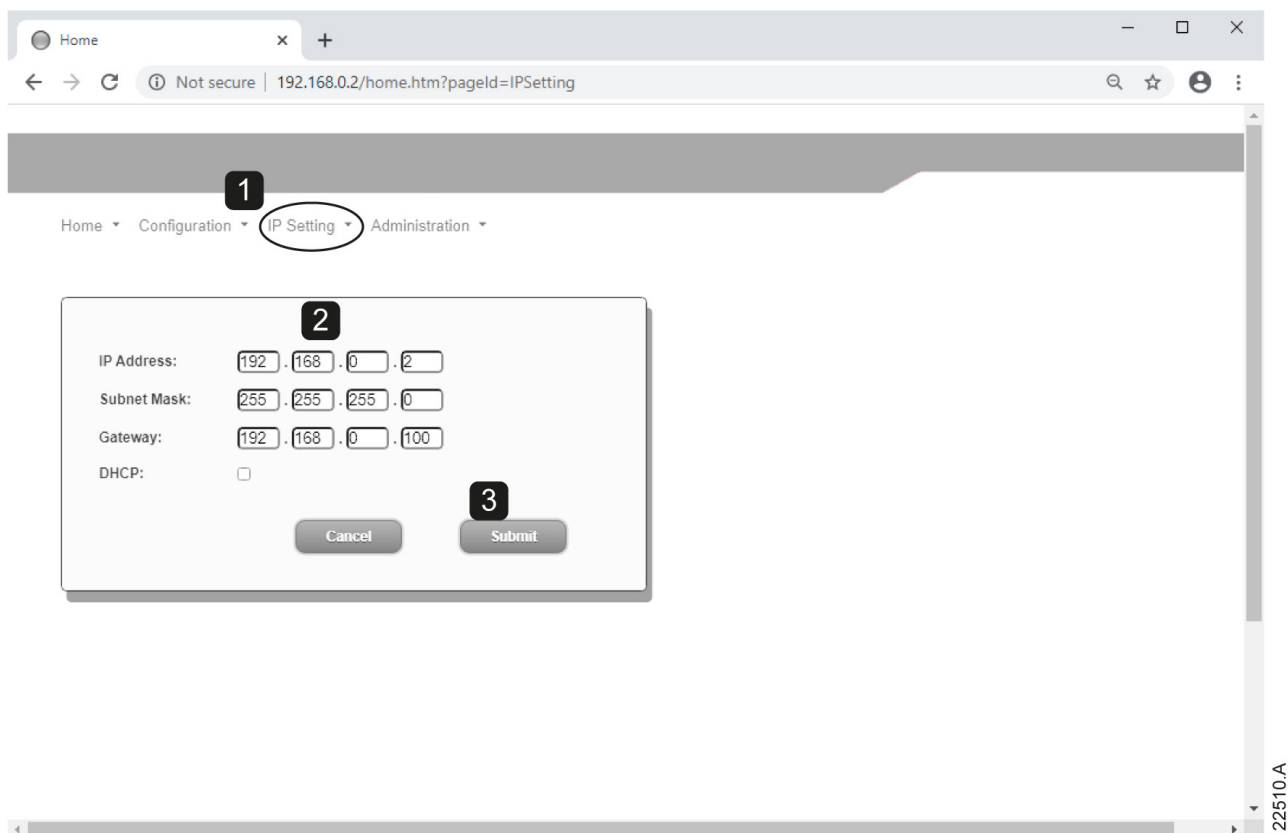

## Configure IoT settings

The Ethernet/IP Card supports soft starter status monitoring over IoT. The card cannot control or program the soft starter.



### NOTE

Version 1.x of the Ethernet/IP Card does not support IoT operation.

### • Configure MQTT settings

1. Connect to the web server then click Configuration > MQTT Client.
2. Tick the Enable checkbox to enable MQTT client operation. The MQTT client is enabled by default.
3. Click Connection then configure the settings as required.
4. Use Connection > Actions to select which information the card will publish.
5. Click Submit to save all settings in the card.

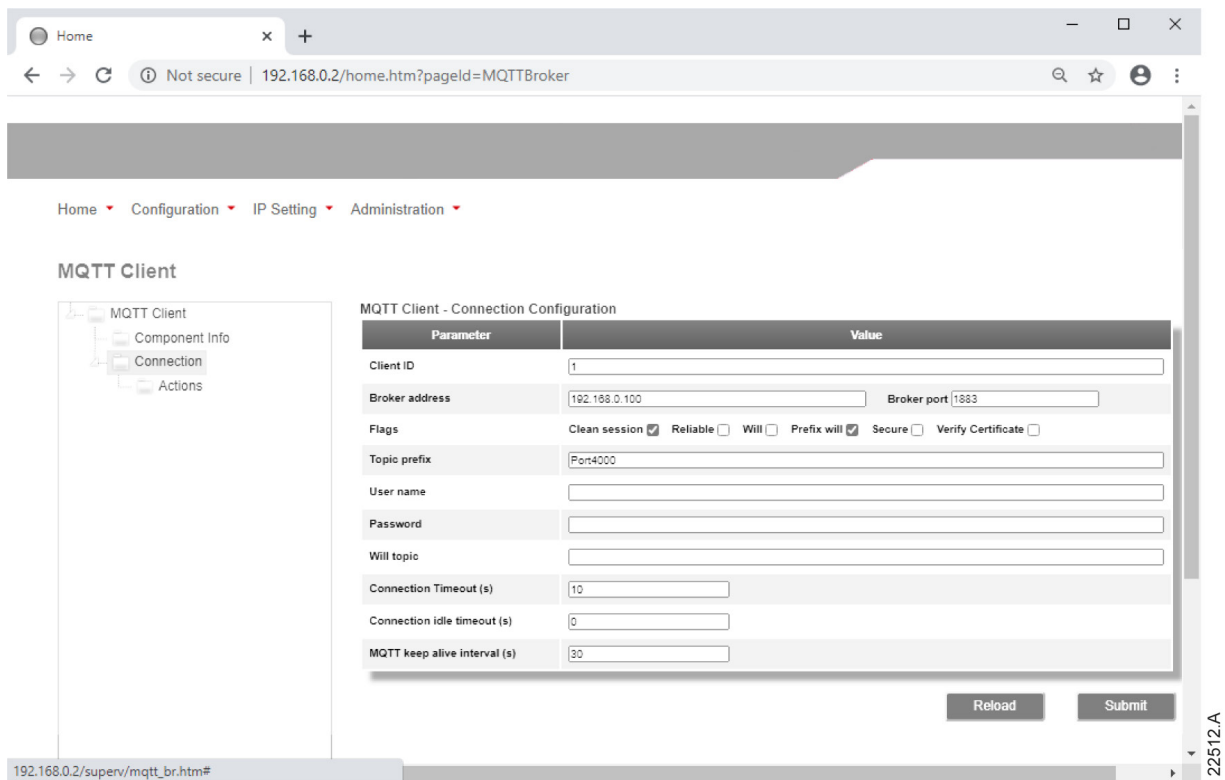

- **Configure OPC UA settings**

1. Connect to the web server then click Configuration > OPC UA Server.
2. Tick the Enable checkbox to enable OPC UA client operation. The OPC UA client is enabled by default.
3. Click Server Configuration then configure the settings as required.
4. Use Actions to select the actions for different object instances.
5. Click Submit to save all settings in the card.

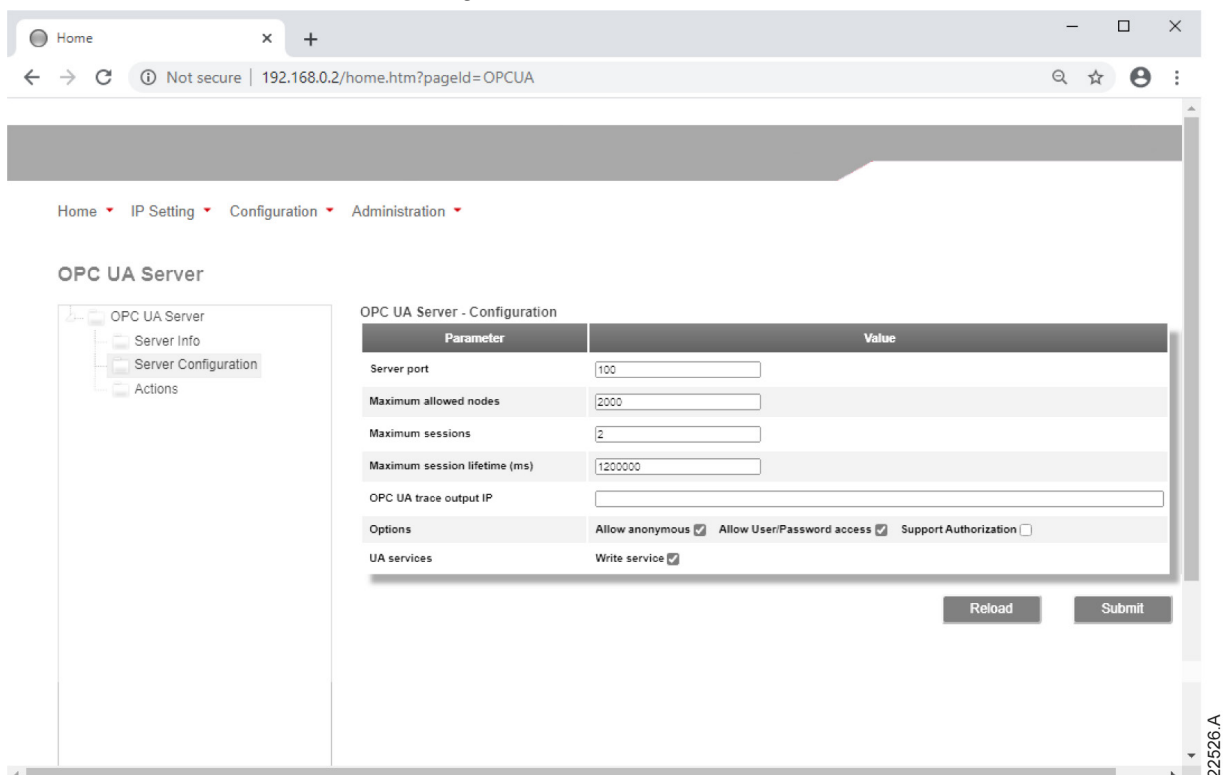

## Scanning the network

If you cannot connect to the web server and cannot physically access the soft starter, use the Ethernet Device Configuration software to scan the network and identify the device. Changes made via the software cannot be stored permanently in the device and will be lost when control power is cycled.

The Ethernet Device Configuration Tool is available from your local supplier.



### NOTE

If your PC has a firewall enabled, you must add the tool to the list of authorised programs.

To identify the device using the Ethernet Device Configuration Tool:

1. Start the Ethernet Device Configuration Tool.
2. Click on Search Devices. The software will search for connected devices.

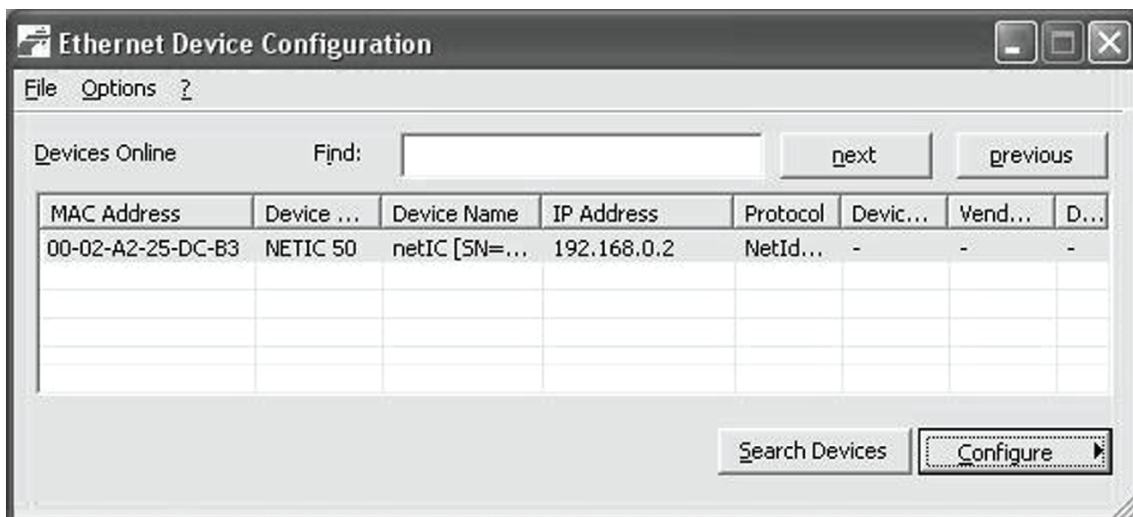

3. Use the IP address to connect to the device via the web server.

## 4. Scanner configuration

### 4.1 EDS file

An EDS file that contains all required attributes of the device is available from your supplier.

Once the EDS file has been loaded, the individual device must be defined.

### 4.2 Assembly objects

The device supports two assembly objects.

Description	Class	Instance	Type	Maximum size
Output (scanner -> starter)	04d (0x04)	100d (0x64)	Integer	2 (4 bytes)
Input (starter -> scanner)	04d (0x04)	101d (0x65)	Integer	6 (12 bytes)

## 5. Ground fault protection



**NOTE**

Ground fault protection is only available on ground fault enabled cards, with soft starters running a compatible version of software. Contact your supplier for assistance.

### 5.1 Overview

The Ethernet/IP Card can detect ground current and trip before the equipment is damaged.

Ground fault protection requires a 1000:1 or 2000:1 current transformer (not supplied). The CT should be rated 1 VA or 5 VA. The soft starter can be configured to trip at 1 A~50 A. If ground fault current rises above 50 A, the soft starter will trip immediately. Parameter 40C *Ground Fault Active* selects when ground fault protection is active.

### 5.2 Connect the CT to the ground fault inputs

To use ground fault protection, a common mode current transformer (CT) must be installed around all three phases. Use a 1000:1 or 2000:1 CT with rating of 1 VA or 5 VA and set parameter 40E *Ground Fault CT Ratio* to match. Connect the CT to the ground fault terminals (G1, G2, G3).

For maximum protection, the CT should be installed on the input side of the soft starter.

### 5.3 Configure ground fault protection settings

Ground fault protection settings must be set in the soft starter.

Parameter	Parameter name	Description
40A	<i>Ground Fault Level</i>	Sets the trip point for ground fault protection.
40B	<i>Ground Fault Delay</i>	Slows the Ethernet/IP Card's response to ground fault variation, avoiding trips due to momentary fluctuations.
40C	<i>Ground Fault Trip Active</i>	Selects when a ground fault trip can occur.
40D	<i>Ground Fault Action</i>	Selects the soft starter's response to the protection event.
40E	<i>Ground Fault CT Ratio</i>	Set to match the ratio of the ground current measuring CT.

## 6. Operation

The Ethernet/IP Card is conformance tested to ODVA. For successful operation, the scanner must also support all functions and interfaces described in this document.



### NOTE

The available features and parameter details may vary according to the model and software version of the starter. Refer to the soft starter user manual for details of parameters and supported features.

### 6.1 Device classification

The Ethernet/IP Card is an I/O Adapter and must be managed by an I/O Scanner over Ethernet.

The Ethernet/IP Card supports both implicit (cyclic) and explicit (acyclic) messaging.

### 6.2 Ensuring safe and successful control

Data written to the device will remain in its registers until the data is overwritten or the device is reinitialised.

If the soft starter may be controlled via Command Override (parameter 7A) or may be disabled via the reset input (terminals 10, 11) fieldbus commands should be cleared from the registers. If a command is not cleared, it will be re-sent to the starter once fieldbus control resumes.

### 6.3 Feedback LEDs

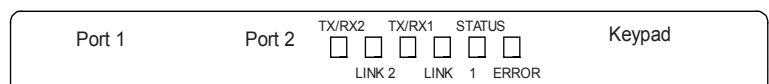

LED name	LED state	Description
Error	Off	Device is not powered up or has received an IP address.
	Flashing	Connection timeout.
	On	Duplicate IP address.
Status	Off	Device is not powered up or has received an IP address.
	Flashing	Device has obtained an IP address but has not established any network connections.
	On	Communication has been established.
Link x	Off	No network connection.
	On	Connected to a network.
TX/RX x	Flashing	Transmitting or receiving data.

## 7. Implicit messaging (cyclic operation)

This section lists requirements related to cyclic (implicit messaging) services for the Ethernet/IP Card.

The minimum cyclic interval is 1 ms.

All data is in little endian format.

### 7.1 Assembly objects

The device supports two assembly objects.

Description	Class	Instance	Type	Maximum size
Output (scanner -> starter)	04d (0x04)	100d (0x64)	Integer	2 (4 bytes)
Input (starter -> scanner)	04d (0x04)	101d (0x65)	Integer	6 (12 bytes)

### 7.2 Control commands (assembly instance 100d)

To send control data from the scanner to the starter, use assembly class 04d (0x04), assembly instance 100d (0x64), attribute 03d (0x03).

#### Bytes 0-1: Command

Bits	Function	Details
0 to 5	<i>Reserved</i>	Must be zero
6	Run	0 = Stop command 1 = Start command
7	Reset	Changing this bit from 0 to 1 will reset a trip.
8 to 12	<i>Reserved</i>	Must be zero
13	Motor set select	0 = Use primary motor set when starting 1 = Use secondary motor set when starting
14 to 15	<i>Reserved</i>	Must be zero

#### Bytes 2-3: Reserved

Bits	Function	Details
0 to 15	<i>Reserved</i>	Must be zero

#### Command Examples

Byte	Value	Description
0	0b01000000 (64d, 0x40)	Command: Start the soft starter
1		Command: Select primary or secondary motor settings

Byte	Value	Description
	0b00000000 (00d, 0x00) or 0b00100000 (32d, 0x20)	Use primary motor set when starting. Use secondary motor set when starting.
0	0b10000000 (128d, 0x80)	Command: Reset the soft starter The reset only occurs when the previous reset bit is zero, otherwise the value of 1 will be ignored.
0	0b11000000 (192d, 0xC0)	Command: Reset and start the soft starter
0	0bX0000000 (00d, 0x00)	Command: Stop the soft starter

### 7.3 Status information (assembly instance 101d)

To retrieve status data from the starter, use assembly class 04d (0x04), assembly instance 101d (0x65), attribute 03d (0x03).

#### Bytes 0-1: Starter state

Bits	Function	Details
0	Ready	0 = Not ready 1 = Ready to start
1	Operating mode	0 = Program mode 1 = Operating mode
2	Running	0 = Not ready, Ready to start or Tripped 1 = Starting, Running, Stopping or Jogging
3	Trip	0 = Not tripped 1 = Tripped
4	Jog forward	1 = Jog forward
5	Jog reverse	1 = Jog reverse
6	<i>Reserved</i>	
7	Warning	0 = No warning 1 = Warning
8	Ramping	1 = Running (full voltage at the motor)
9	Command source	0 = Remote Keypad, Digital Input, Clock 1 = Network
10	<i>Reserved</i>	
11	<i>Reserved</i>	
12	<i>Reserved</i>	
13	<i>Reserved</i>	
14	<i>Reserved</i>	
15	Temperature limit	0 = Motor operating within thermal capacity (thermal model) 1 = Motor operating above thermal capacity (thermal model)

## INSTRUCTIONS

---

### Bytes 2-3: Reserved

Bits	Function	Details
0 to 15	<i>Reserved</i>	

---

### Bytes 4-7: Motor current

Bits	Function	Details
0 to 31	Motor current	Average rms current across all three phases. Measured current is represented as a 32-bit value to 2 decimal places. 10d (0x0A) = 0.10 A 3450d (0xD7A) = 34.50 A 68930d (0x10D42) = 689.30 A

---

### Bytes 8-9: Trip code

Bits	Function	Details
0 to 15	Trip code	Refer to Trip codes on page 20

---

### Bytes 10-11: Reserved

Bits	Function	Details
0 to 15	<i>Reserved</i>	

---

## 8. Explicit messaging (acyclic operation)

This section provides information on objects, instances, attributes and services for acyclic operation (explicit messaging).

All data is in little endian format.

### 8.1 Identity object (Class 0x01)

The Ethernet/IP Card supports the following attributes for identity objects:

Attribute	Function	Value
1	Vendor	204d (0xCC)
2	Device type	12d (0x0C)
3	Product code	269d (0x10D)
4	Revision: Major, Minor	EDS file version
5	Status	Supported
6	Serial number	Supported
7	Product name	Supported

---



## 8.2 Vendor-specific objects

The Ethernet/IP Card supports vendor-specific classes 100, 101, 102, 103 and 104.

### Class 100~102 Objects (Read/Write)

Class 100~102 objects allow parameter values to be read from and written to the soft starter.

- Class 100d (0x64): parameters 1~99
- Class 101d (0x65): parameters 100~199
- Class 102d (0x66): parameters 200~299



#### NOTE

Parameter lists vary according to the model and version of soft starter. Refer to the relevant soft starter literature for a complete parameter list.

### Class 103 objects (read only)

Class 103d (0x67) allows starter state information to be read from the soft starter.

Object name	Class	Instance	Attribute
Binary protocol version	103	100	100
Product type code	103	101	100
<i>Reserved</i>	103	102	100
<i>Reserved</i>	103	103	100
Soft starter model	103	104	100
Changed parameter number	103	105	100
Number of parameters	103	106	100
Changed parameter value	103	107	100
<i>Reserved</i>	103	108	100
Starter state	103	109	100
1 = Ready			
2 = Starting			
3 = Running			
4 = Stopping (including braking)			
5 = Restart delay (including temperature check)			
6 = Tripped			
7 = Programming mode			
8 = Jog forward			
9 = Jog reverse			
Warning	103	110	100
1 = Warning, 0 = No warning			

## INSTRUCTIONS

Object name	Class	Instance	Attribute
Initialised 1 = Phase sequence is valid	103	111	100
Phase sequence (1 = Positive phase sequence, only valid if Initialised =1)	103	112	100
<i>Reserved</i>	103	113	100
<i>Reserved</i>	103	114	100
Trip/Warning code (Refer to Trip codes on page 20)	103	115	100
Average rms current across all three phases	103	116	100
Current (% motor FLC)	103	117	100
Motor temperature	103	118	100
<i>Reserved</i>	103	119	100
Power	103	120	100
Power scale 0 = Multiply power by 10 to get W 1 = Multiply power by 100 to get W 2 = Power (kW) 3 = Multiply power by 10 to get kW	103	121	100
% Power factor	103	122	100
Average rms voltage across all three phases	103	123	100
Phase 1 current	103	124	100
Phase 2 current	103	125	100
Phase 3 current	103	126	100
Phase 1 voltage	103	127	100
Phase 2 voltage	103	128	100
Phase 3 voltage	103	129	100
Parameter list minor revision	103	130	100
Parameter list major version	103	131	100
Digital input state For all inputs, 0 = open, 1 = closed (shorted) Start/stop input = 01h, Reset = 04h, Programmable input A = 08h, Programmable input B = 10h	103	132	100
Trip code	103	133	100
<i>Reserved</i>	103	134	100
Frequency	103	135	100
Ground current	103	136	100



### NOTE

The reset input is normally closed by default. If parameter 7I *Reset/Enable Logic* is set to normally open, the reported state will be inverted (0 = closed, 1 = open).

**NOTE**

For models EMX4x-0064B and smaller, current reported via communications is 10 times greater than the actual value (displayed on the keypad).

**NOTE**

Frequency reported via communications is 10 times greater than the actual value (displayed on the keypad).

**Class 104 objects (read only)**

Class 104d (0x68) allows extended information to be read from the soft starter.

Object name	Class	Instance	Attribute
Major Software Version – User interface	104	101	100
Minor Software Version – User interface	104	102	100
Major Software Version – Motor control	104	103	100
Minor Software Version – Motor control	104	104	100
Major Software Version – Remote keypad (if installed)	104	105	100
Minor Software Version – Remote keypad (if installed)	104	106	100

**8.3 Supported services for vendor-specific objects**

This section describes the operational instructions to carry out acyclic services on class objects 100, 101, 102, 103 and 104.

**Service codes for acyclic operation**

The device supports the following services for vendor-specific objects:

Service code	Function	Description
01d (0x01)	Get Attribute All	Only supported for class 0x01 identity object
10d (0x10)	Set Attribute Single	Supported
15d (0x0E)	Get Attribute Single	Supported

**Status codes for acyclic services**

The device will return the following status codes in response to Get/Set Attribute Single:

Status code	Status name	Details
00d (0x00)	Success	This code is returned when: <ul style="list-style-type: none"> <li>the register mapped for service 'Get Attribute Single' is successfully read</li> <li>the register mapped for service 'Set Attribute Single' is successfully set</li> </ul>

## INSTRUCTIONS

Status code	Status name	Details
03d (0x03)	Invalid parameter value	
05d (0x05)	Path destination unknown	The mapped register does not exist.
08d (0x08)	Service not supported	The requested service is not available for this Object Class/Instance.
09d (0x09)	Invalid attribute value	This code only applies to the service 'Set Attribute Single'. It is returned if the value is out of range for the mapped register.
15d (0x0E)	Attribute not settable	This code only applies to the service 'Set Attribute Single'. It is returned if the mapped register is read-only.
20d (0x14)	Attribute not supported	The attribute specified in the request is not supported.
22d (0x16)	Object does not exist	The object specified does not exist in the device.

## 9. Attributes

### 9.1 Trip codes

Code	Trip type
0	No trip
11	Input A trip
20	Motor overload
21	Heatsink overtemperature
23	L1 phase loss
24	L2 phase loss
25	L3 phase loss
26	Current imbalance
27	Ground fault
28	Overcurrent
29	Undercurrent
50	Power loss
51	Undervoltage
52	Overvoltage
54	Phase sequence
55	Frequency
60	Incorrect control card
61	FLC out of range
62	EEPROM fail (Parameter out of range)

Code	Trip type
75	Motor thermistor
101	Excess start time
102	Motor connection
104	Internal fault
110	Input B trip
113	Communications card fault
114	Network communication
115	L1-T1 shorted
116	L2-T2 shorted
117	L3-T3 shorted
119	Bypass overload
120	SCR overtemperature
121	Battery/clock
122	Thermistor circuit
124	RTD/PT100 B
133	Overpower
134	Underpower
142	Keypad disconnected
143	Zero Speed Detect
144	SCR Itsm
145	Instantaneous overcurrent
146	Rating Capacity
156	Current Read Err L1
157	Current Read Err L2
158	Current Read Err L3
160	Motor Connection T1
161	Motor Connection T2
162	Motor Connection T3
163	Firing Fail P1
164	Firing Fail P2
165	Firing Fail P3
166	VZC Fail P1
167	VZC Fail P2
168	VZC Fail P3
169	Low Control Volts
170~182	Internal fault x. Contact your local supplier with the fault code (X).

# 10. Network Design

The device supports star, line and ring topologies.

## 10.1 Star Topology

In a star network, all controllers and devices connect to a central network switch.

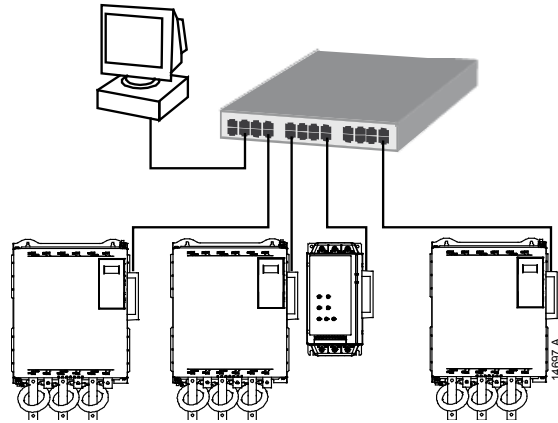

## 10.2 Line Topology

In a line network, the controller connects directly to one port of the first card. The second Ethernet port connects to another card, which in turn connects to another device until all devices are connected.

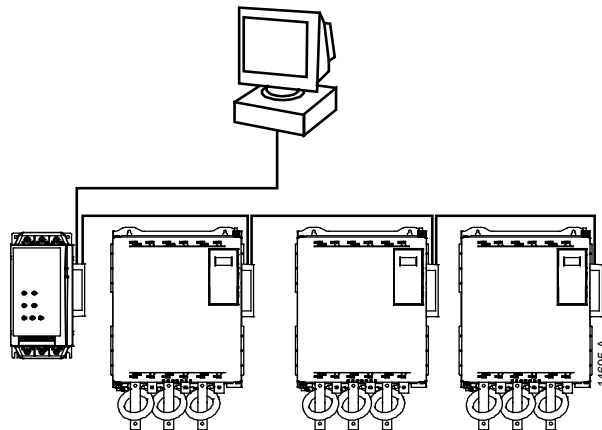

**NOTE**

The device has an integrated switch to allow data to pass through in line topology. The device must be receiving control power from the soft starter for the switch to operate.



**NOTE**

If the connection between two devices is interrupted, the controller cannot communicate with devices after the interruption point.

**NOTE**



Each connection adds a delay to communication with the next device. The maximum number of devices in a line network is 32. Exceeding this number may reduce the reliability of the network.

## 10.3 Ring Topology

In a ring topology network, the controller connects to the first card, via a network switch. The second Ethernet port of the card connects to another device, which in turn connects to another device until all devices are connected. The final device connects back to the switch.

The device supports beacon based ring node configuration with DLR (device level ring) redundancy.

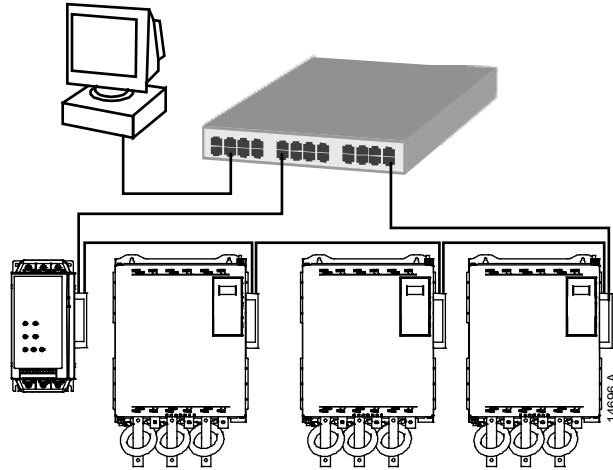

### NOTE

The network switch must support loss of line detection.

## 10.4 Combined Topologies

A single network can include both star and line components.

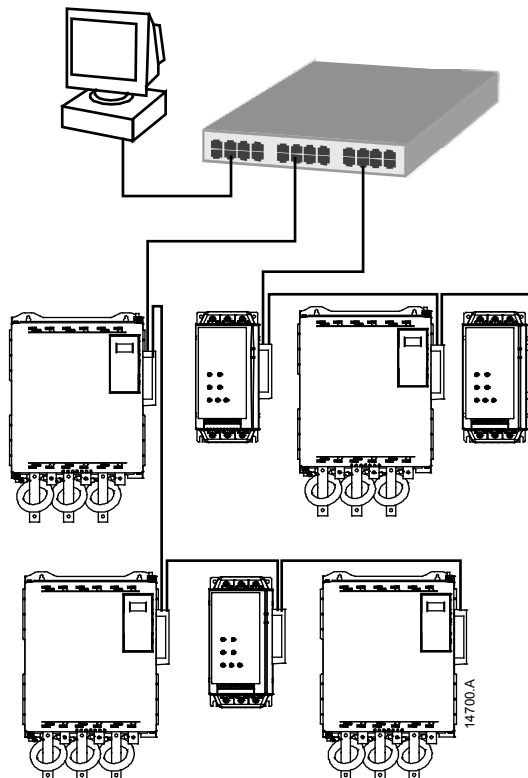

# 11. Specifications

- **Connections**

Soft starter ..... 6-way pin assembly  
Contacts ..... Gold flash  
Network ..... RJ45

- **Settings**

IP address ..... Automatically assigned, configurable  
Device name ..... Automatically assigned, configurable

- **Network**

Protocols ..... Ethernet/IP, MQTT, OPC UA  
..... DHCP, ACD (address conflict detection), DLR (device level ring)  
Link speed ..... 10 Mbps, 100 Mbps (auto-detect)  
Full duplex  
Auto crossover

- **Power**

Consumption (steady state, maximum) ..... 35 mA @ 24 VDC  
Reverse polarity protected  
Galvanically isolated

- **Certification**

RCM ..... IEC 60947-4-2  
CE ..... EN 60947-4-2  
ODVA .....  **EtherNet/IP**  
conformance tested

